

**FEATURES:**

- for use with 24" dia. wood shelves or larger
- set contains: top pivot bracket, bottom pivot bracket, upper shaft assembly, lower shaft assembly, 2 shelf supports, screws, template, and instructions
- 1" dia. center post
- center post has adjustable height range of 26-1/2" to 34"
- adjustable thumb wheel for final height adjustment
- support brackets for shelves can be located at any height
- chrome plated steel center post

**APPLICATION:**

A hardware kit for the customer who wishes to make her/his own shelves for a lower corner kitchen cabinet.

**SPECIFICATIONS:**

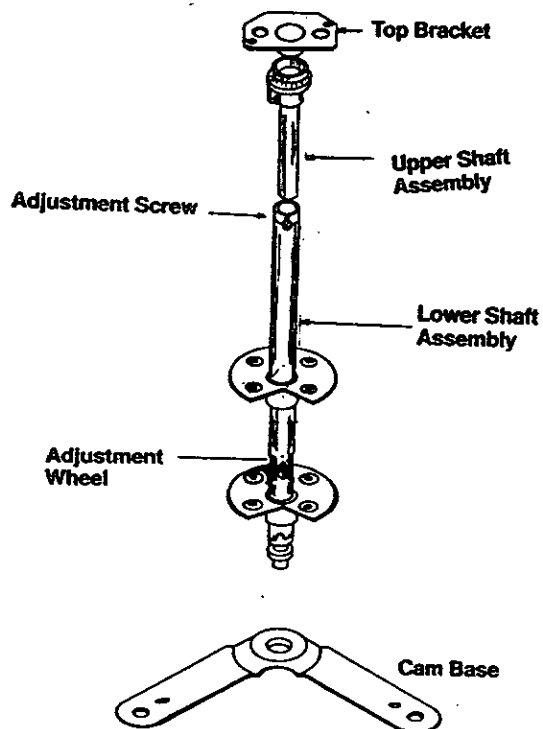

## INSUFFICIENT SIDE CLEARANCE ADJUSTMENT

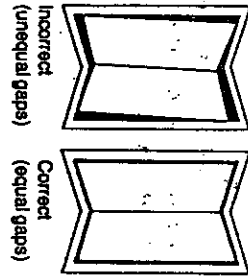

### Step 1 Top Adjustment

Remove and discard shipping screws (if used).  
Loosen star washer screws to re-center pivot.  
Tighten, check and repeat if necessary.

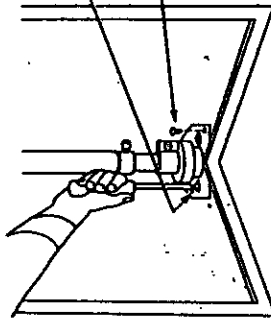

### Step 2 Bottom Adjustment

Rotate door to expose screws on bottom bracket.  
Remove and discard shipping screws (if used).  
Loosen star washer screws to re-center pivot cam base (both sides). Tighten, check and repeat if necessary.

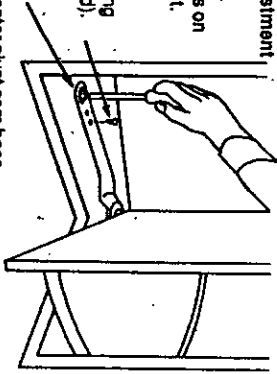

## UNEVEN OR INCOMPLETE DOOR CLOSING ADJUSTMENT (To center in the frame correctly for proper clearance)

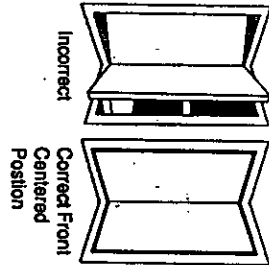

Step 1  
Loosen clamp screw in white plastic housing (approx. 1 turn) to prepare for positioning adjustment.

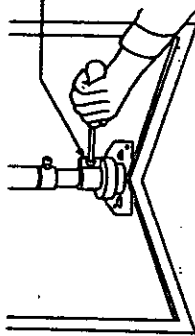

### Step 2

Rotate door counter-clockwise until white plastic housing has been latched into position with spring. A resistance to turning will be felt when the housing reaches the latched position and may be accompanied by a click or latching sound.

### Step 3

Rotate door slowly clockwise to exact front centered position but not past it. Release door to check alignment. You may need to rotate door a little past center to allow for slight spring-back. If you rotate too far, go back to step 2 and repeat.

### Step 4

SLOWLY rotate door counter-clockwise far enough so that clamp screw faces you again. Tighten clamp screw securely, being careful not to rotate white plastic housing out of position.

## TOP/BOTTOM CLEARANCE ADJUSTMENT

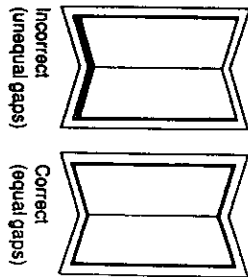

Step 1  
Loosen black thumb screw.

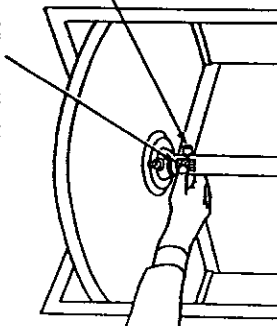

### Step 2

Turn adjustment wheel (located inside cut out portion of shaft) clockwise to raise shelf/door unit. One full turn raises door 1/32". After adjustment, be sure to re-tighten thumb screw.

Note: If shelves are heavily loaded, lift lower shelf slightly to aid adjustment. Total adjustment 1/2".

Note: When adjustments are completed, be sure to securely tighten all adjustment screws in housing, shaft bushing and tray adjustment screws.

Tools required for adjustments:  
Phillips Screwdriver