

Lower Center Web Frames

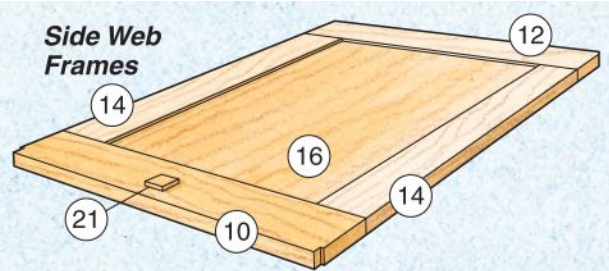

Side Web Frames

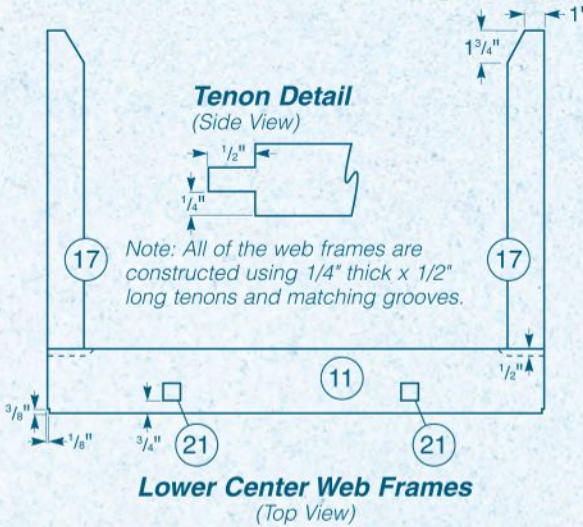

Side Web Frames
(Top View)

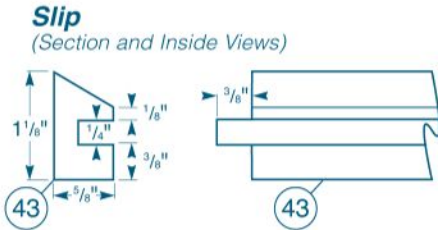
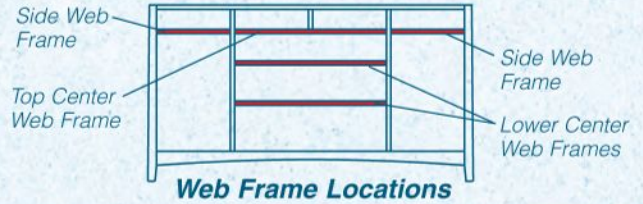
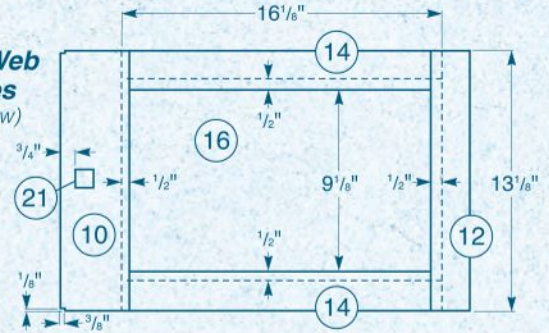

Exploded View

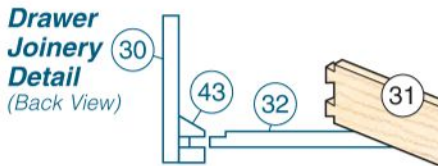
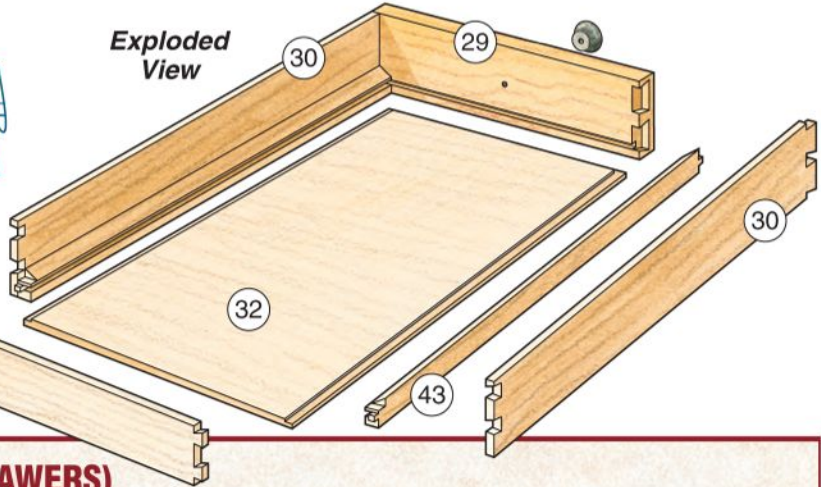

MATERIAL LIST (DOORS/DRAWERS)

	T x W x L
25 Door Stiles (4)	3/4" x 1 3/4" x 20 1/2"
26 Door Top Rails (2)	3/4" x 1 3/4" x 10 3/8"
27 Door Bottom Rails (2)	3/4" x 2" x 10 3/8"
28 Door Panels (2)	5/8" x 10 3/8" x 17 3/4"
29 Top Drawer Fronts (4)	3/4" x 3 1/2" x 12 7/8"
30 Top Drawer Sides (8)	3/8" x 3 1/2" x 19 3/4"
31 Top Drawer Backs (4)	3/8" x 2 3/4" x 11 3/8"
32 Top Drawer Bottoms (4)	3/8" x 19 1/2" x 11 3/8"
33 Second Drawer Front (1)	3/4" x 4 3/4" x 26 3/4"
34 Second Drawer Sides (2)	1/2" x 4 3/4" x 19 3/4"

	T x W x L
35 Second Drawer Back (1)	1/2" x 4" x 25 3/4"
36 Third Drawer Front (1)	3/4" x 6 1/4" x 26 3/4"
37 Third Drawer Sides (2)	1/2" x 6 1/4" x 19 3/4"
38 Third Drawer Back (1)	1/2" x 5 1/2" x 25 3/4"
39 Forth Drawer Front (1)	3/4" x 8" x 26 3/4"
40 Forth Drawer Sides (2)	1/2" x 8" x 19 3/4"
41 Forth Drawer Back (1)	1/2" x 7 1/4" x 25 3/4"
42 2 nd , 3 rd , & 4 th Dr. Bottoms (3)	3/8" x 19 1/2" x 25"
43 Slips (14)	5/8" x 1 1/8" x Cut to fit